

	0 488 05	0 488 06	0 488 07
	100 - 240 V~	100 - 240 V~	100 - 240 V~
	50 / 60 Hz	50 / 60 Hz	50 / 60 Hz
	2 x 2,5 mm ²	2 x 2,5 mm ²	2 x 2,5 mm ²
	-5°C / +45°C	-5°C / +45°C	-5°C / +45°C
	ULTRASONIC	PIR / ULTRASONIC	PIR
	500 lux	500 lux	500 lux
	15 mn	15 mn	15 mn
	Ø 8 m	Ø 8 m	Ø 8 m

230 V~	2000 W	1000 VA	4,3 A	10x(2x36 W)	4,3 A	500 VA	2,1 A	1000 VA	4,3 A	500 VA	2,1 A	I max. ≤ 2A
110 V~	1000 W	500 VA		5x(2x36 W)		250 VA		500 VA		250 VA		

- (*) Ne pas mélanger différents modèles de charge sur le même produit
- (*) Use only with transformers designed to function with electronic switches

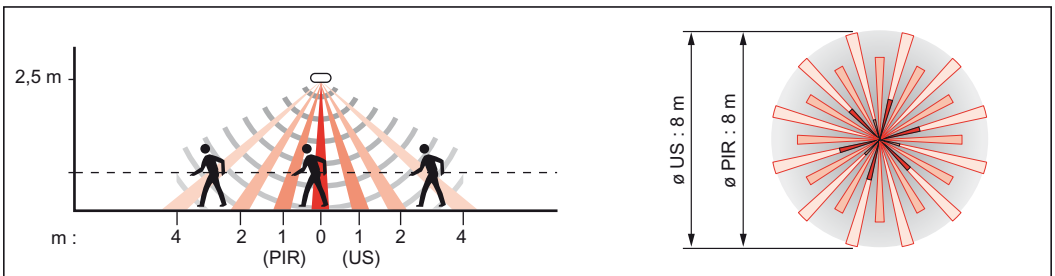

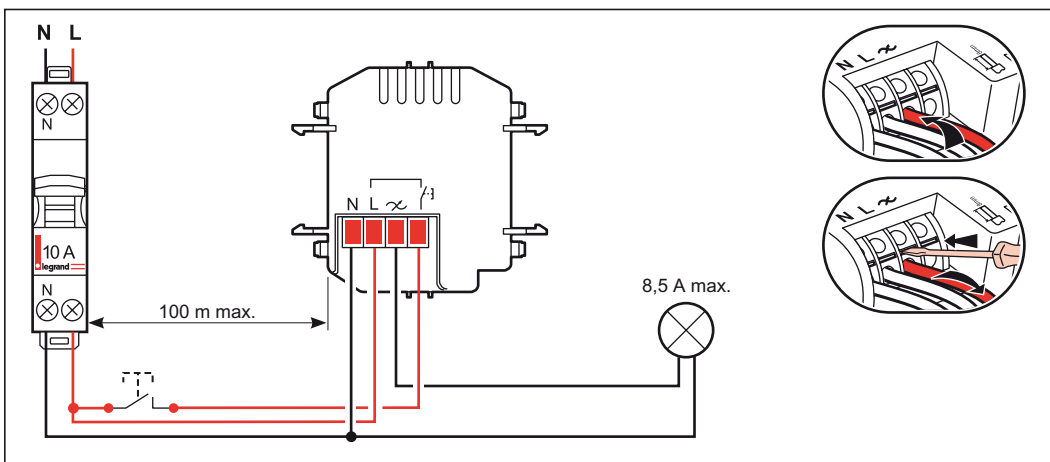
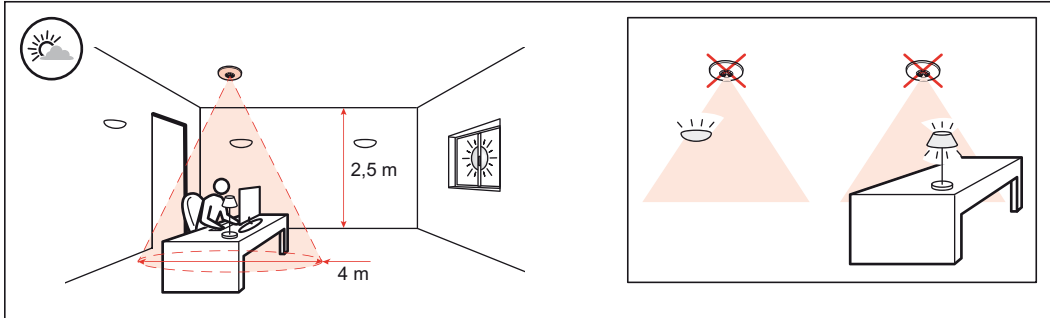
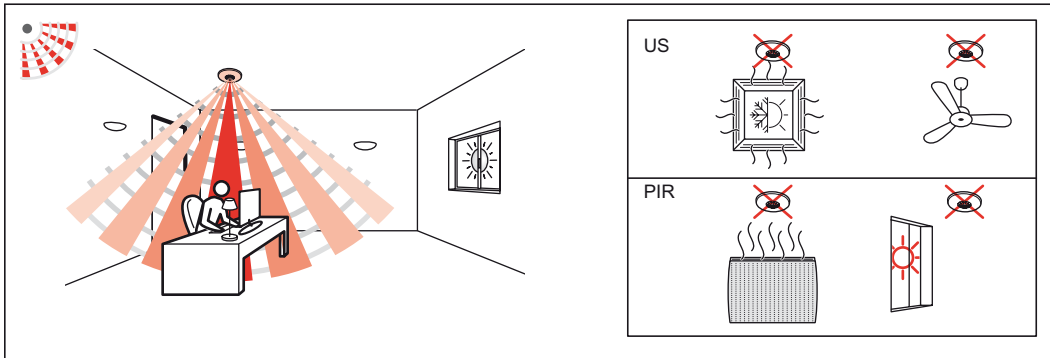
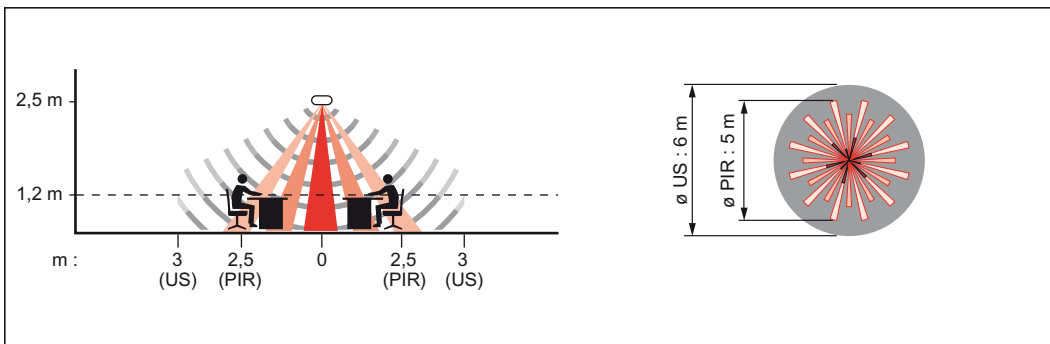

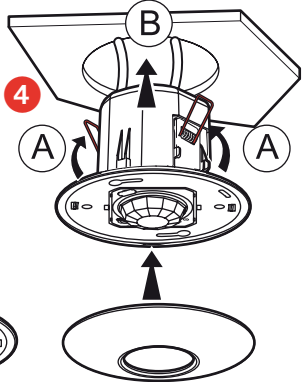
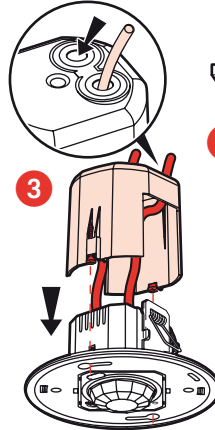
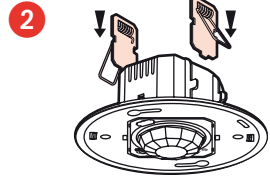
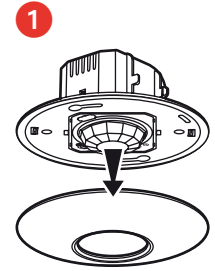
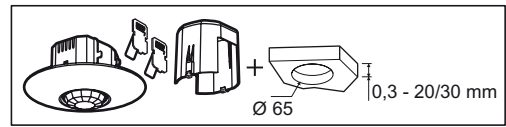
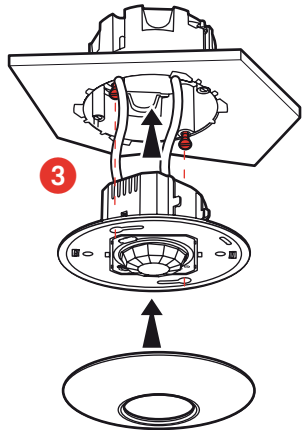
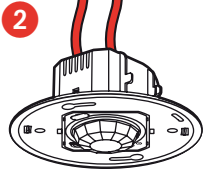
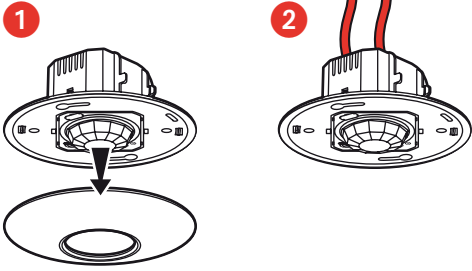
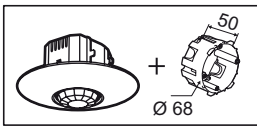

0 488 05/06

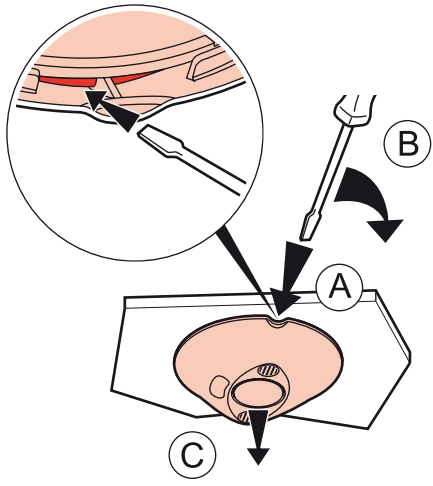

0 488 07

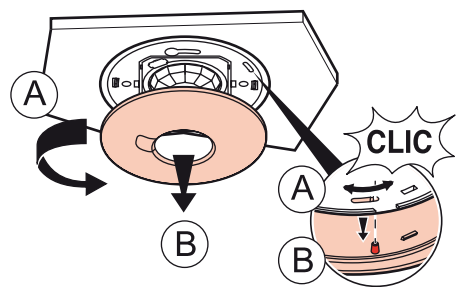



Auto ON/OFF



Manual ON / Auto OFF



www.legrandoc.com



0 882 30



0 882 35

	5 - 1275 lux
	5 sec - 59 min 59 sec
	25% - 50% - 75% - 100%
Mode	Auto- Manual

